

Specifications:

Step Angle: 1.8 Degree

Frame Size: NEMA 11

Body Length (in): 1.26

Body Length (mm): 32.0

Current (AMP): 1.30

Holding Torque (oz-in): 9.2

Holding Torque (N-m): 0.06

Resistance: 1.70

Rotor Inertia (oz-in²): 0.05

Number of leads: 4

Connection: Bipolar

Weight (lbs): 0.24

Branding: MiniStep Compact

Vacuum Rating:

211-13-02 24VDC, 1.3 Amps/Phase, Bipolar, 1/2 Stepping

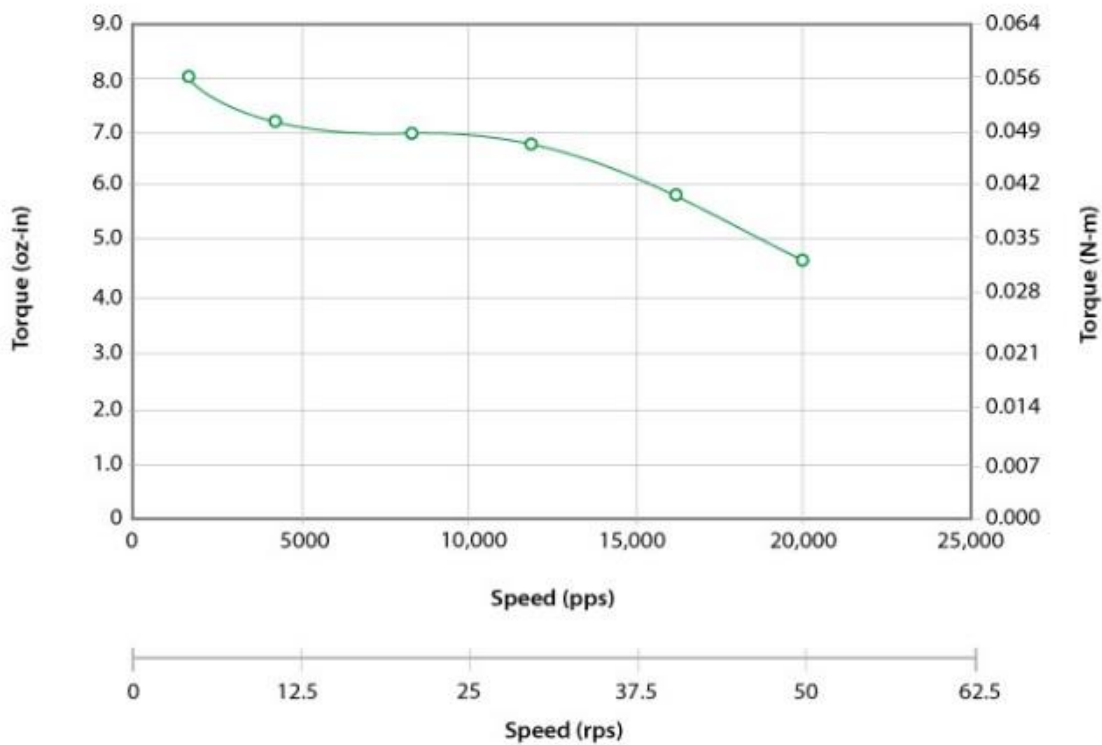

Standard Motor Dimensions

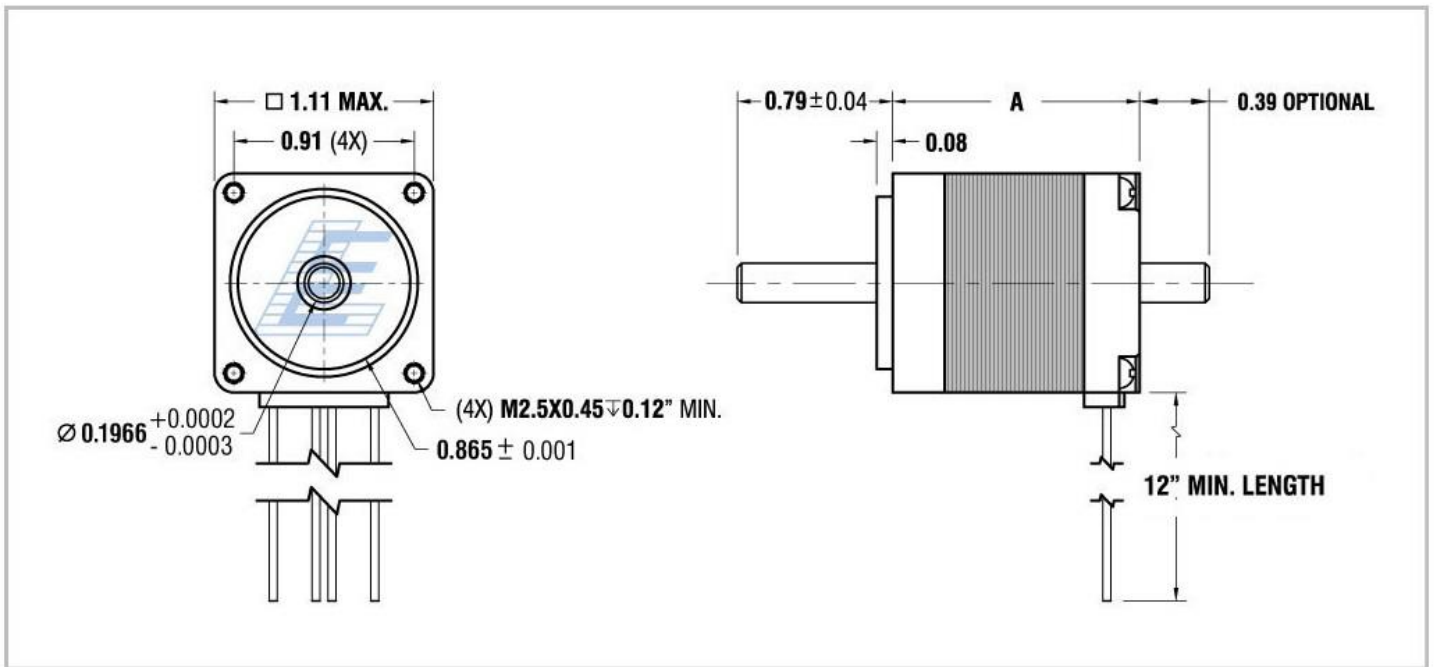

Model Number:	Length A (in)	Length A (mm)
211-13-01	1.26 in	42.0 mm
211-13-01L	1.26 in	42.0 mm
211-13-01DL	1.26 in	42.0 mm
211-13-02L	1.26 in	42.0 mm
211-13-02DL	1.26 in	42.0 mm
211-18-02L	1.7 in	45.0 mm
211-18-02DL	1.7 in	45.0 mm
211-20-01L	2.1 in	51.0 mm
211-20-0DL	2.1 in	51.0 mm
211-20-02L	2.1 in	51.0 mm
211-20-01DL	2.1 in	51.0 mm